

# KSS Series Subminiature Side Actuated Tact Switch for SMT



## Features/Benefits

- Low profile of 1.6 mm
- Excellent tactile feel
- High shear force
- Range of actuation forces
- Large flat top
- Redundant contacts option
- Date code marking
- IP 40 sealed
- RoHS compliant and compatible

## Typical Applications

- Cellular phone
- PDA, pagers
- Industrial electronics
- Health diagnostic electronics

## Specification

FUNCTION: momentary action  
 CONTACT ARRANGEMENT: N.O.  
 TERMINALS: Gullwing / 3-Way type for SMT  
 IP40 sealed

## Mechanical

Type	Operating force Newtons (grams)	Operating life (operations)	Travel
KSS221G	2.0 (200) ± 25%	100,000	0,3 ± 0,15
KSS231G	2.5 (250) ± 20%	100,000	0,3 ± 0,10
KSS233W	2.5 (200) ± 25%	100,000	0,3 ± 0,15
KSS241G	4.0 (400) ± 25%	100,000	0,3 ± 0,15

**NOTE:** Specifications listed above are for switches with standard options.  
 For information on specific and custom switches, consult Customer Service Center.

## Electrical

	Silver	Gold
MAXIMUM POWER:	1 VA	0.2 VA
MAXIMUM VOLTAGE:	32 VDC	32 VDC
MAXIMUM CURRENT:	50 mA	10 mA
MINIMUM CURRENT:	1 mA	1 mA
DIELECTRIC STRENGTH:	≥ 250 VDC	
CONTACT RESISTANCE:	≤ 100 mΩ	
INSULATION RESISTANCE (100 VDC):	≥ 10 <sup>9</sup> Ω	
BOUNCE TIME:	≤ 3 ms	

## Environmental

	Silver	Gold
OPERATING TEMPERATURE:	-40°C to 85°C	-40°C to 125°C
STORAGE TEMPERATURE:	-55°C to 85°C	-55°C to 125°C

## Process

SOLDERING: Compatible with the lead free soldering profile.

## Packaging

Switches are delivered in tape and reels of 3,000 pieces. The reel diameter is 330mm (12.992 x .15). The tape dimensions conform to the EIA-RS-481 and CE-2863 norms.

## How To Order

Our easy build-a-switch concept allows you to mix and match options to create the switch you need. To order, select desired option from each category and place it in the appropriate box.

**However, please note that all the combinations of these options are not feasible.**

**For any part number different from those listed above, please consult your local ITT representative.**

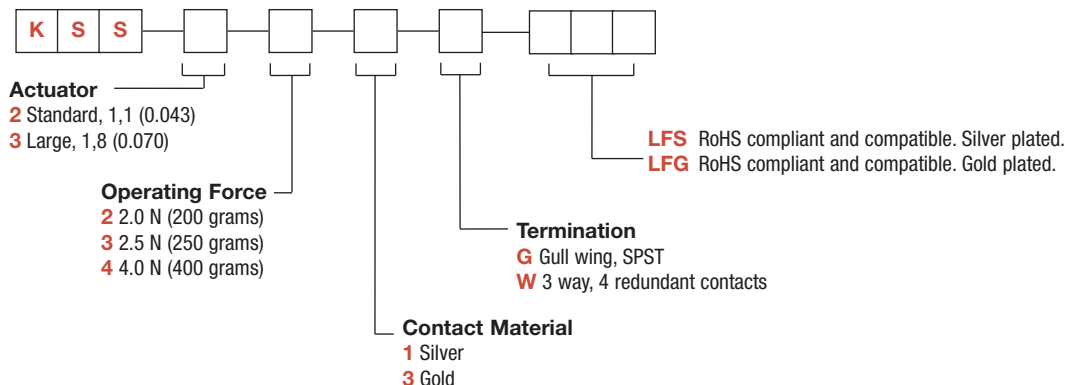

# KSS Series Subminiature Side Actuated Tact Switch for SMT

KSS



KSS221G

Each piece is date code printed:  
1st Line: 9308 = Year 1999, 308 day in the year  
2nd Line: 221XA = Manufacturing code.

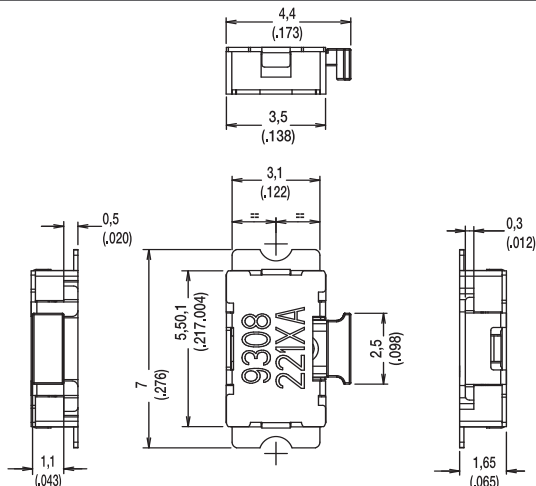

## ACTUATOR

2 STANDARD, 1,1 (0.043)

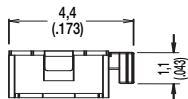

3 LARGE, 1,8 (0.070)

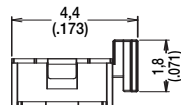

## TERMINATION

G GULLWING

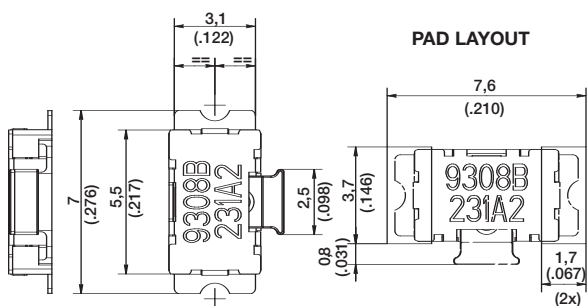

W 3 WAY, 4 REDUNDANT CONTACTS

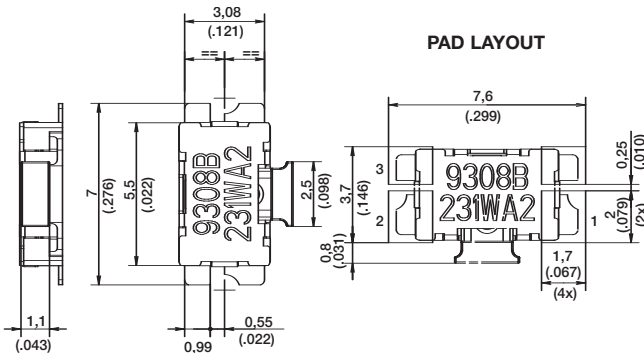

## TAPE & REEL

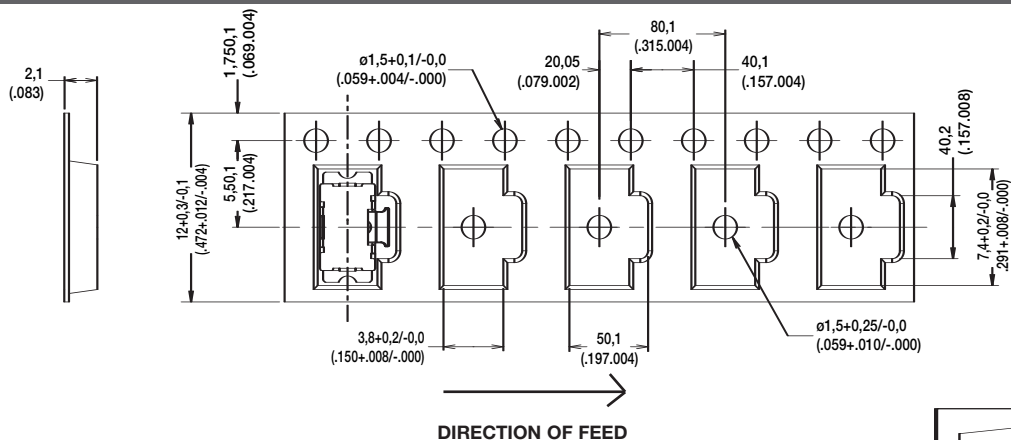

DIRECTION OF FEED



Dimensions shown in: mm (inch)  
Specifications and dimensions subject to change

www.ittcannon.com



Tactile Switches